

UVX Radiometer

Instruction Guide



UVP, LLC
2066 W. 11th Street
Upland, CA 91786
Phone: (800) 452-6788
Fax: (909) 946-3597

Ultra-Violet Products Ltd.
Unit 1, Trinity Hall Farm Estate
Nuffield Road, Cambridge CB4 1TG UK
Phone: +44(0)1223-420022
Fax: +44(0)1223-420561

Web Site: www.uvp.com

81-0064-01 Rev M

Table of Contents

General Instructions	5
Introduction	5
Features.....	5
Specifications	6
Operating Procedures	6
Radiometer Details.....	9
Circuit Description	9
Radiometer Circuit Calibration	9
Radiometer Maintenance	10
Sensor Details.....	15
Sensor Characteristics	15
Calibration Information	15
Sensor Maintenance.....	19
General Precautions.....	19
Application Techniques	22
Definition of Radiant Incidence.....	22
Wavelength Considerations.....	22
Cosine Response	25
Summary	25
Safety Precautions	26
Component List, Replacement Parts, and Options.....	29
Component List	29
Replacement Parts	30
Options	30
Warranty.....	31

List of Figures

Figure 1: Rear and Side Views of Radiometer.....	4
Figure 2: Radiometer Functional Block Diagram	13
Figure 3: Calibration Current Source	14
Figure 4: LCD Display Pin-outs.....	14
Figure 5: UVX-25 Sensor Solarization Curve	16
Figure 6: Typical UVX-25 Sensor Spectral Response.....	16
Figure 7: Typical UVX-31 Sensor Spectral Response.....	17
Figure 8: Typical UVX-36 Sensor Spectral Response.....	17
Figure 9: Typical Sensor Response Versus Incidence Angle.....	18
Figure 10: Schematic of UVX Series Sensor.....	20
Figure 1: Measurement of Irradiance.....	20
Figure 12: Typical Output From Low Pressure Mercury Lamp.....	21
Figure 13: Hypothetical Light Source Having an Output at 270nm Wavelength	24
Figure 14: Response of Three Sensors Calibrated to Yield the Same Output at 254nm Wavelength.....	24
Figure 15: Continuous Emitter, 285nm Phosphor Coated UV Lamp.....	25
Figure 16: Example, Illustrating Why Sensor Field of View is Important When Measuring Irradiance.....	27
Figure 17: Projected Area of Sensor.....	27
Figure 18: Cosine Response of Typical UVX Sensor (Polar Plot)	28

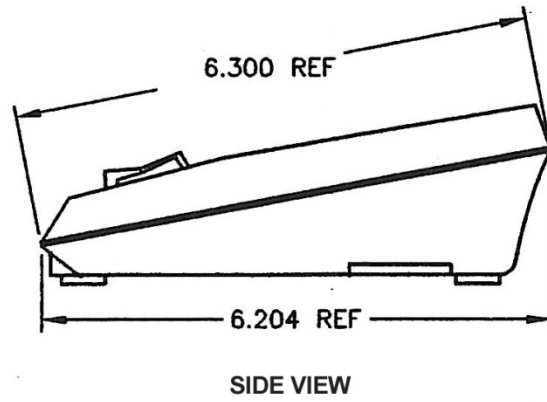
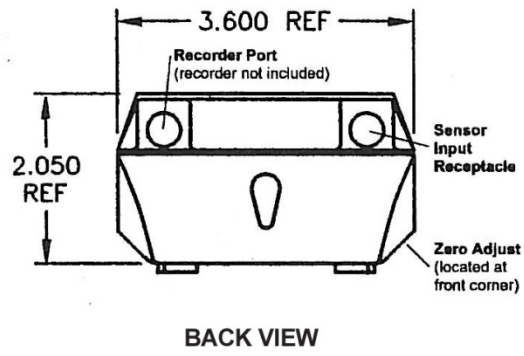

Figure 1: Rear and Side Views of Radiometer

General Instructions

Introduction

Your new UVX Digital Radiometer from UVP allows measurement of UV intensities quickly and easily. The digital readout is in radiometric units with a broad dynamic range from $0.1 \mu\text{W}/\text{cm}^2$ to $20 \text{mW}/\text{cm}^2$ with accuracy and precision traceable to the National Institute of Standards and Technology (NIST). The sensors are cosine corrected for measuring UV radiation at 254, 310 and 365nm. Each sensor is also pre-calibrated and quickly interchangeable with any other sensor without affecting the overall system accuracy.

Designed for simplicity and durability, the UVX is built with the latest in solid state electronics, has a rugged housing, over-ranging, and low battery indicators. By using circuitry that is powered by a single 9V transistor battery, UVX is completely portable. It can be used in a wide variety of research and industrial applications. Some typical applications using UV light sources are: genetic experiments, photochemical reactions, sterilization procedures, optical lab measurements, experimental biology, dermatology research, NDT techniques and graphics procedures.

The UVX Series Sensor supplied with this unit, as well as all other UVX Series Sensors, is designed and calibrated for measurement of radiant incidences from line type and phosphor coated mercury arc sources. There are several parameters including calibration, spectral response and sensor field of view which users should understand to ensure accurate measurements. Refer to the Applications Techniques section of this manual, which addresses these subjects.

Features

The following is a list of features provided by the UVX Radiometer and Sensor:

- Three sensitivity ranges covering the span from $200 \mu\text{W}/\text{cm}^2$ to $20 \text{mW}/\text{cm}^2$
- 3-1/2 digit liquid crystal display readout
- Sensitivity down to $0.1 \mu\text{W}/\text{cm}^2$
- Outstanding ruggedness and reliability
- Negligible sensitivity to infrared
- Linearity of $\pm 1\%$ over the total range, \pm one digit
- Readout and sensor are stored in their own storage and carrying case with room for one additional sensor
- Light weight
- Powered by a single 9V transistor battery
- Long battery life (more than 120 hours of continuous operation with a single alkaline battery)
- Automatic low voltage battery indication ("LOBAT" or ":" displayed on the LCD screen)
- Not sensitive to capacitive or AC pick up
- Fully interchangeable sensors for full UV band coverage
- Automatic circuit that tests the display each time the unit is turned on
- Read/Hold switch that allows holding any reading indefinitely
- Automatic reverse battery connection protection circuit
- Calibration of sensors is traceable to NIST through a standard lamp and proven laboratory techniques
- Independent calibration of all sensors and digital Radiometers allowing complete interchangeability without reference to individual calibration factors
- Remote sensor of small size permitting measurements to be taken in constricted areas
- Three foot long electrically shielded connecting cable
- 1/4-20 UNC-2B threaded mounting hole compatible with standard tripod mount screws

- Excellent cosine response with typical curve supplied in the manual
- A filter system which significantly reduces shortwave solarization phenomenon
- Internal temperature correction retains the accuracy of the sensors at both high and low temperatures
- Externally accessible zero adjust
- Connector port for an external chart recorder (recorder not included)

Optional Accessories

- A 10-to-1 attenuator allowing readings to be made up to 200mW/cm².

Specifications

Radiometer

Conversion Rate:	2.8 readings/sec
Display:	3-1/2 digit LCG
Accuracy:	±2.5%
Linearity:	±0.2%
Resolution:	1 part in 1999
Sensitivity Ranges:	0 to 199.9 μW/cm ² 0 to 1999 μW/cm ² 0 to 19.99 mW/cm ² 0 to 199.9 mW/cm ² w/10:1 Attenuator
Temperature Coefficient:	±0.025%/°C ± 1 digit, 0 to 50°C
Zero Drift:	±0.02 uW/cm ² /°C nominal 0 to 50°C
Power:	9V transistor battery
Battery Life (Alkaline):	120 Hrs (without recorder output option)

Sensor

Spectral Response:	See Figures 6, 7, 8
Accuracy:	±5% (includes NIST standard)
Linearity:	±1.0%
Cosine Response:	See Figure 9
Temperature Coefficient:	±0.04%/°C nominal, 0 to 40°C
Zero Drift:	±0.35 uW/cm ² /°C nominal 0 to 50°C

Operating Environment

Temperature:	0 to 50°C
Humidity:	5% to 90% RH

Operating Procedures

The UVX Radiometer provides versatility and simplicity of operation. The number of front panel controls has been held to a minimum. Range changes are made by means of a three position range switch. Access to the zero adjust trimpot is available through the hole in the left hand side of the case. This simplifies the operation of the instrument and also minimizes operator error.

The procedure that follows will help in understanding the operation of this instrument.

- Turn the Radiometer over and open the battery cover to determine if the battery has been installed. If it has not, snap the battery clip in place, insert the battery into the holder, then close the battery cover.
- Plug the UVX sensor into the mating connector at the left rear of the UVX Radiometer. This receptacle is identified in Figure 1.

Note: The connector goes through two "snap" positions before it is fully inserted. Failure to insert the connector all the way will result in erroneous readings.

- Place the three position range switch in the 20 mW/cm² position. Place the READ/HOLD switch in the READ position.
- Turn the unit on by placing the OFF-ON/TEST switch in the ON/TEST position.

Note: For the first second of operation, the entire display will be turned on demonstrating that all segments, decimal points and "LOBAT" (the low battery indicator shown on the upper left corner, for 2014 and newer models) on the display are functioning properly. The readout you should see during that one second period, if everything is functioning correctly, is "LOBAT" (for 2014 and newer models) and "-18:8.8". If any one of these segments is not on during this time, refer to the Troubleshooting tips in this manual.

NOTE: A low battery will be indicated by "LOBAT" text on the display on 2014 and newer models, or a colon (":") for 2013 and older models.

After the one second test mode is completed, the circuit will automatically revert to the normal read status.

- At this time, the meter should be zeroed to assure the best accuracy. This is done by first covering the sensor so that no UV light strikes the sensor window. (Generally, turning the sensor upside down on a bench will suffice.) The range switch is then placed in the 200 $\mu\text{W}/\text{cm}^2$ position and the zero adjustment trimpot for a display reading of 00.0 $\mu\text{W}/\text{cm}^2$.
- After setting the zero, ultraviolet readings may be taken by placing the sensor in the UV environment. The resultant intensities will be shown on the display.

CAUTION

Refer to the Safety Precautions section of this manual before making ultraviolet measurements with this Radiometer. If all the digits are blank except for the leading “1” when the sensor has been placed in the UV radiant incident field, an overrange condition is indicated. This may be corrected by switching to a less sensitive range or by moving the sensor away from the UV source. If this is impractical, then the optional 10:1 Attenuator must be used.

If, however, the reading contains less than three significant digits, use a more sensitive scale or move the sensor closer to the source.

To hold a reading after it has been obtained, change the position of the HOLD/READ switch to the HOLD position. This will hold the reading until the switch is returned to the READ position.

In the event the battery voltage falls below that necessary to ensure accurate operation, “LOBAT” text will be shown on the display on 2014 and newer models, or a colon (“:”) for 2013 and older models. When this happens, turn off the Radiometer and replace the battery with a new one.

Radiometer Details

Circuit Description

This section describes how the UVX Radiometer operates. Three illustrations are included for use in conjunction with this section. Figure 2 is a Functional Block Diagram.

Current to Voltage Converter

The silicon detector used in the sensor may be modeled as a current source. For maximum linearity, the detector load should represent a short circuit. The input amplifier on the board meets this requirement and converts the input current to a voltage that is then applied to the analog to digital (A/D) converter. A switchable 4, 40, or 400:1 voltage divider in the amplifier feedback loop allows the current gain selection required to produce a readout directly in the appropriate units of measure.

A/D Converter

The A/D chip used in this circuit is a high performance, low power 3-1/2 digit converter, complete with seven segment decoder, display drives, internal reference and a clock. This chip retains the high accuracy of much more expensive units by providing an auto-zero to less than 10 μV , zero drift of less than $1\mu\text{V}/^\circ\text{C}$, and roll over error of less than one count. The output of the chip drives the LCD directly.

Decimal Point Circuitry

The decimal point circuitry operates through a C-MOS chip to drive the appropriate decimal point as the range is changed.

Low Battery Voltage Circuit

A low battery is detected by means of comparing a diode reference voltage to the trip-point of an exclusive OR gate. When the battery voltage decreases to less than 7.0v, "LOBAT" text will be shown on the display on 2014 and newer models, or a colon (":") for 2013 and older models.

HOLD/READ Circuit

The A/D chip is equipped with "hold" function pin which, when driven high (by the READ/HOLD switch), holds the currently displayed reading.

ON/TEST Circuit

The ON/TEST circuit applies a one second DC signal to the back-plane of the LCD, forcing all the segments to come on. After one second, the TEST portion of the circuit returns the unit to normal operation.

Radiometer Circuit Calibration

This section refers to the calibration of the Radiometer, not of the sensor. UVP recommends recalibration of the Radiometer every 6 months and provides calibration services for a nominal fee. Contact the factory for details.

Note: Should the user attempt to perform a calibration on the Radiometer prior to the end of the warranty period, then the warranty on the Radiometer becomes void.

Required test equipment for those who wish to calibrate their own Radiometer:

- Variable current with range from .005 μA to 1.0 μA . Note: See Fig 3 for a calibration current source
- Precision microammeter measures current source output
- 500 K ohm resistor ($\pm 0.1\%$)
- 5 to 9 V DC adjustable power supply (10mA or more)
- 0 to 10V DC digital voltmeter
- Small Phillips head screwdriver
- Small flat head screwdriver for trimpot adjustment

Procedure

Calibration

- Remove the battery. Remove the two screws from the bottom of the case and carefully lift off the bottom. As you do this, feed the battery clip through the aperture in the side of the battery holder. Place the bottom of the case aside and lift the PC board out of the case top. Set the PC board on the test bench.
- Be sure the OFF-ON/TEST switch is in the OFF position.
- Connect the DC power source to the plus and minus terminals of the battery clip. Note: The plus side of the battery snap is the larger of the two. Set the voltage of the power supply at 9V DC.
- Connect the DC voltmeter ground connection to pin 40 of the A/D converter chip. Connect the plus side of the DC voltmeter to pin 44 of the A/D converter chip.
- Turn the 9V DC power on and depress the ON/TEST switch. This will apply power to the circuit. Measure the voltage between pin 44 and pin 40.
- If the voltage is not 1.000 volts DC, adjust RV3 until this indication is obtained.
- Disconnect the voltmeter from the circuit.
- Reduce the power supply voltage to 7.00V DC.
- While viewing the display, adjust trimpot RV2 until "LOBAT" (2014 and newer models) or a colon ":" (2013 and older models) begins to appear on the display. Achieving this sets the low battery voltage indication circuit.
- Check for proper low battery voltage indication by reducing the supply voltage to 6.8 volts and see that "LOBAT" or the colon (":") is fully visible. Then increase the supply voltage to 7.20V DC and see that "LOBAT" or the colon (":") is completely off.
- Return the supply voltage to 9.0 volts DC.
- Place the range selector switch in the 200 $\mu\text{W}/\text{cm}^2$ position.
- Adjust trimpot RV1 until the display shows 00.0
- This completes the calibration procedure.

Ranging

- Connect the current source to the input connector as shown on Figure 3.
- Set the current source for an output of 0.00500 μA .
- Set the range switch to the 200 $\mu\text{W}/\text{cm}^2$ position. The display should now read 100.00 ± 2.5 $\mu\text{W}/\text{cm}^2$
- Change the current to 0.0500 μA .
- Set the range switch to the 2000 $\mu\text{W}/\text{cm}^2$ position. The display should now read 1000 ± 25 $\mu\text{W}/\text{cm}^2$.
- Change the current to 0.500 μA . Set the range switch to 20 $\mu\text{W}/\text{cm}^2$. The display should now read 10.00 ± 25 $\mu\text{W}/\text{cm}^2$.
- This completes the test of the ranges of the unit.

Turn off the unit by depressing the OFF switch, disconnect the power supply and test equipment and reassemble the circuit board back into the case. Test the equipment and reassemble the circuit board back into the case.

Radiometer Maintenance

Care of Radiometer Case

The case of the UVX Radiometer is fabricated from a durable ABS plastic. As with all plastics, solvents should not be used for cleaning the case. A high quality plastic cleaner or mild soap and water should be used to clean fingerprints, dust or dirt from the case.

Note: Do not use abrasive cleaners on the Radiometer. The contacts for the sensor input and the recorder output are recessed and should not require attention.

Troubleshooting Procedures

In the event the Radiometer malfunctions, the following procedures will enable the user to determine the source of error and affect repairs.

If any of the active circuit elements are replaced in the following procedures, then the calibration procedure must be performed prior to putting the Radiometer back into service.

Troubleshooting Tips

The following paragraphs detail some of the more common malfunctions of the circuit and give the basic procedures by which the cause of the circuit malfunction can be determined and ultimately corrected. These procedures are limited to those active elements that can be easily removed and replaced.

Remove the circuit board from the case. Check the battery voltage to make sure it is still above 7.0 volts. If it is, connect the battery back into the circuit. If it is not, replace it with a new battery.

Note: In the event any component is removed and replaced as a result of any work done on this unit, then the full calibration procedure must be performed.

- **Display segment does not turn on:**

Turn the unit on and observe the display during the first second of operation: i.e. during test mode. In this case the display should indicate "LOBAT" (for 2014 and newer models) and -18:8.8. In the event any of the segments of the display is not on, it may indicate that a contact is not making a firm connection at the liquid crystal display.

To correct this, use a pencil tip and place it on the pin contact of the malfunctioning segment. (Refer to Figure 4 for the display pin-outs) Carefully work the contact pin back and forth with the pencil tip and watch the segment. Performing this operation will generally correct all display segment malfunctions.

- **"LOBAT" (2014 and newer models) or colon (":" on 2013 and older models) does not appear on the display:**

If "LOBAT" / ":" does not appear during the test mode, refer to the previous troubleshooting topic. If "LOBAT" / ":" does not operate as a result of low battery voltage conditions and a new battery has already been installed, then proceed as follows.

Disconnect the battery from the circuit and connect the circuit to a variable 0 to 10 volt DC power supply. Set the power supply voltage at 9 volts. Turn the power supply and the unit on.

Slowly reduce the output of the DC power supply to 7.0 volts. If "LOBAT" / ":" does not appear, then the trimpot RV2 is out of adjustment or the integrated circuit U2 is malfunctioning.

With the power supply set at 7.0 volts, adjust trimpot RV2 fully counterclockwise then fully clockwise. If "LOBAT" / ":" does not come on at any time during this adjustment, then the integrated circuit U2 is malfunctioning. Remove U2 and replace it with a new integrated circuit.

- **Decimal point does not turn on:**

Turn the unit on and place the range switch in the position in which the decimal point should be on. Connect the negative input of the voltmeter to the negative side of the battery.

If the decimal point that should be on is the one corresponding to the 20 $\mu\text{W}/\text{cm}^2$ range, then connect the positive side of the voltmeter to pin 9 of integrated circuit U2. If the decimal point that is not on corresponds to the 200 $\mu\text{W}/\text{cm}^2$ range, connect the positive input of the voltmeter to pin 12 of integrated circuit U2.

When the range switch is in the appropriate position for the decimal point to be on, the voltmeter should read the battery supply voltage; i.e., 9.0 volts. When the range switch is in some other

position, then the voltmeter should read less than 5 volts DC.

If the voltmeter indicates correctly according to the above requirements and the decimal point fails to come on, then the integrated circuit U2 is malfunctioning and must be replaced. If the voltmeter does not indicate as described above, then the malfunction is in the range selector switch and the UVX must be returned to UVP.

- **Display does not turn on:**

If the display fails to turn on immediately check the lead wires from the battery to make sure they are not broken, also check the battery for an output of at least 7.0 volts. Also check the snaps on the battery connectors. Be sure the snap fingers are pinched together for good contact when snapped onto the battery terminals. If all these check out correctly, then integrated circuit U4 is malfunctioning and must be replaced.

- **Test mode does not operate:**

Turn the unit on and momentarily connect a jumper between the plus side of the power supply and pin 1 of integrated circuit U2. NOTE: Do not leave the jumper connected longer than a few seconds. To do so may cause permanent damage to the Liquid Crystal Display.

During that time the test mode condition should be displayed on the readout. If the display shows the test mode correctly, then the malfunction is in the ON/TEST switch and the unit must be returned for repair. If it is not, then integrated circuit U2 is malfunctioning and must be replaced.

- **Hold mode does not operate:**

Turn the unit on and connect the DC voltmeter between the negative side of the battery and pin 8 of integrated circuit U4. Switch from READ to HOLD. The voltmeter should indicate the battery voltage while the switch is in the HOLD position.

If the voltmeter indicates the battery voltage, and the display does not remain steady, then the malfunction is in the integrated circuit U4 and it must be replaced. If the voltmeter does not indicate the battery voltage, then the malfunction is in the switch and the unit must be returned to UVP for repair.

- **No display change with UV intensity changes:**

Disconnect the sensor from the sensor input jack. Connect a 500K resistor between pin 2 of integrated circuit U1 and the junction between resistors R1 and R3. Connect a variable source between pin 3 (-) and 2 (+) of integrated circuit U1. Set the current source for an output of .00500 micro amps.

Turn the unit on and set the range switch to the 200 $\mu\text{W}/\text{cm}^2$ position.

Connect the negative side of a DC digital voltmeter to pin 3 of integrated circuit U1 and the positive side to pin 6. Turn the unit on.

For normal operation, the display should read 100.0 $\mu\text{W}/\text{cm}^2$ and the voltmeter should read 1.00 volts. If the display is not indicating correctly or not at all and the voltmeter is indicating 1.00 volts, then integrated circuit U4 is malfunctioning and must be replaced.

If the voltmeter is not indicating 1.00 Volts, then the input amplifier U1 is malfunctioning and must be replaced.

Change the range switch to the 2000 $\mu\text{W}/\text{cm}^2$ position. The voltmeter indication should be 0.100 volts and the display should read 100 $\mu\text{W}/\text{cm}^2$. If the voltmeter did not change from 1.00 volts, down to 0.100 volts, then the malfunction is in the range changing switch and the unit must be returned to UVP for repair.

Change the range switch to the 20 uW/cm^2 position. The display should now indicate 0.10 uW/cm^2 and the voltmeter should read $.0100 \text{ volts}$. Again, if the voltmeter indication did not decrease by a factor of 10, then the malfunction is in the range changing switch and the unit must be returned to UVP for repair.

In the event the input amplifier, U1, the range changing switch, and integrated circuit, U4, are found to be functioning correctly, then the malfunction is in the UVX sensor.

Note: For direct traceability to NIST standards, the sensor must be returned to UVP for repair and recalibration. Refer to the section in the manual on Sensor Details.

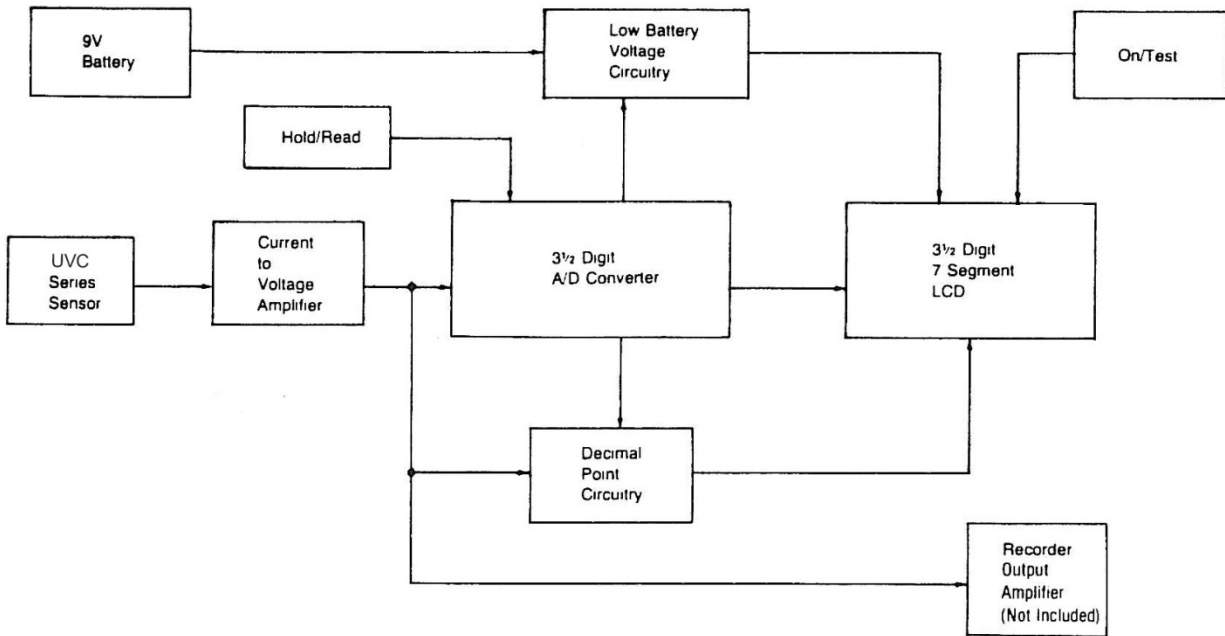

Figure 2: Radiometer Functional Block Diagram

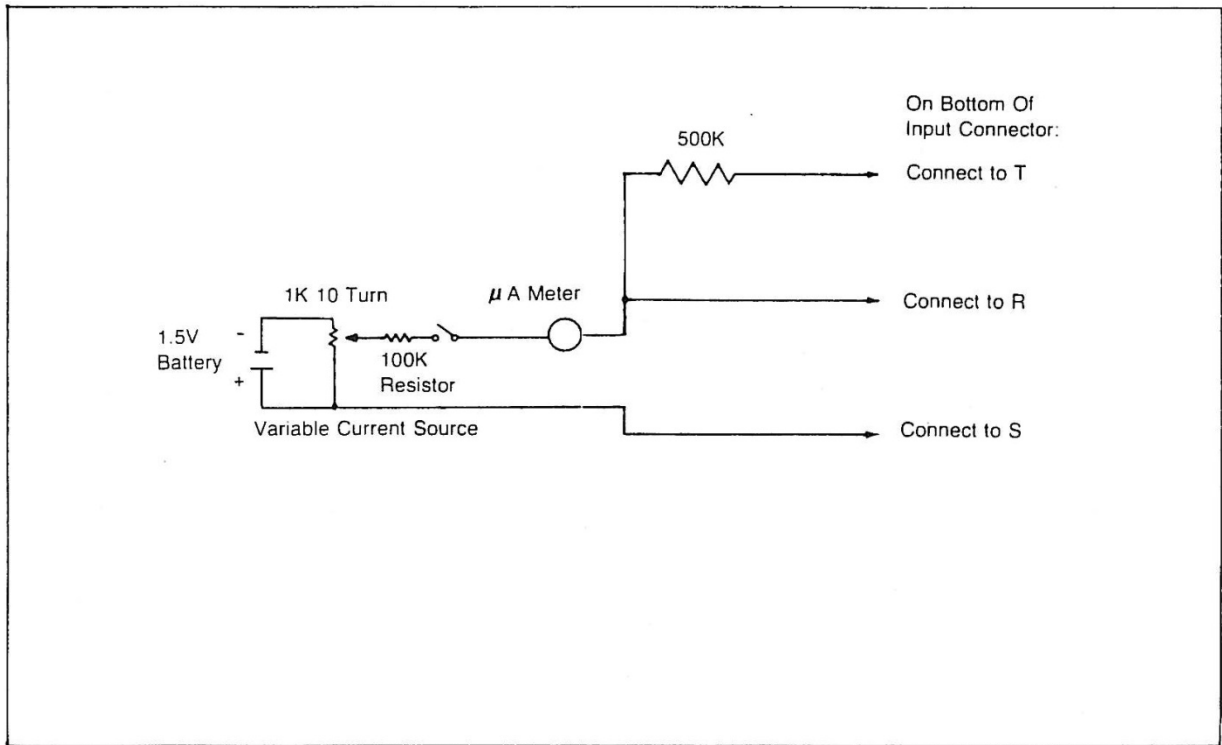

Figure 3: Calibration Current Source



Figure 4: LCD Display Pin-outs

Sensor Details

Sensor Characteristics

Solarization of Filters

Shortwave ultraviolet radiation causes a decrease in sensor output that is proportional to total exposure. This is due to changes in the transmission properties of the filters; a phenomenon called solarization. Solarization is especially noticeable in the 254nm sensors. Only a small amount is seen in the midrange (310nm) sensors and virtually none in the longwave (365nm) sensors. In typical shortwave sensors operating at 254nm, solarization begins immediately and reduces the sensor output at a rate of about 0.4% per mW-h/cm². To correct this problem, the UVX shortwave (254nm) filters incorporate a new design that significantly reduces the short term solarization effect. This is shown in Figure 5 where it can be seen that solarization does not begin to take effect until after 50mW-h/cm² total dosage and then at the reduced rate of 0.1% per mW-hcm².

Spectral Response Curves

Figures 6, 7 and 8 show the typical spectral response characteristics of the UVX 25, 31 and 36 Series Sensors (respectively). In each case the absolute response curve is typical. Individual sensors may exhibit variations in response at wavelengths distant from the calibration wavelength, but all are accurately calibrated to a response of 1.00 at the specified calibration wavelength.

Sensor Temperature Coefficient

An added feature of the UVX Series Sensors is that special circuitry has been incorporated to reduce the temperature induced errors present in all solid state detectors. The result is a sensor with a nominal overall temperature coefficient of only $\pm 0.04\%/^{\circ}\text{C}$ from 0 to 40°C.

Sensor Response Versus Incidence Angle

The UVX Series Sensors incorporate a unique diffuser at the incident surface. This diffuser enables the sensor to detect radiation to incidence angles of $\pm 81^{\circ}$ from the normal. Figure 9 shows the real response of the UVX Series Sensors, as compared to the perfect cosine response curve, with sufficient detail that analytical corrections can be made where accurate measurements of large UV sources are required.

Calibration Information

Authorized Calibration Service

Please note this section refers to the calibration of sensors, not the Radiometer. UVP maintains a calibration laboratory to recalibrate UVX Series Sensors. A nominal fee is charged for this service. To verify such a recalibration, the date of the most recent calibration is placed on the label attached to the sensor and a certificate of calibration is included with the returned sensor. It is suggested that the first recalibration take place 6 months after the initial unpacking and use of the use of the unit, not 6 months from the initial calibration date on the sensor. Periods of time spent sealed on the dealer's shelves have negligible effect on the accuracy of the calibration.

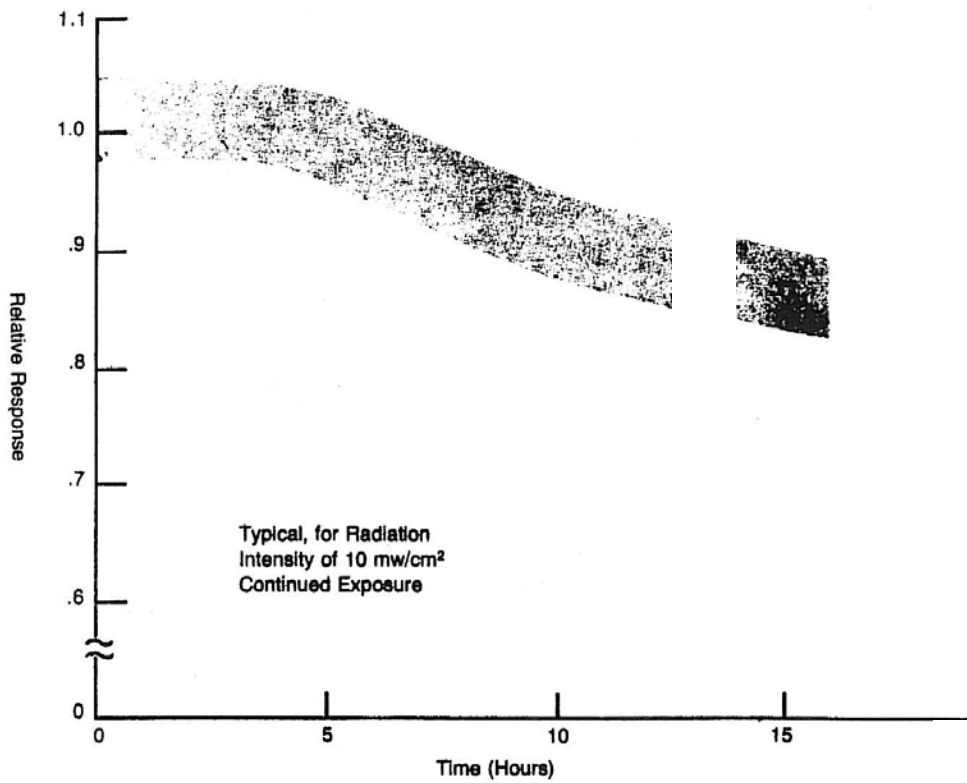

Figure 5: UVX-25 Sensor Solarization Curve

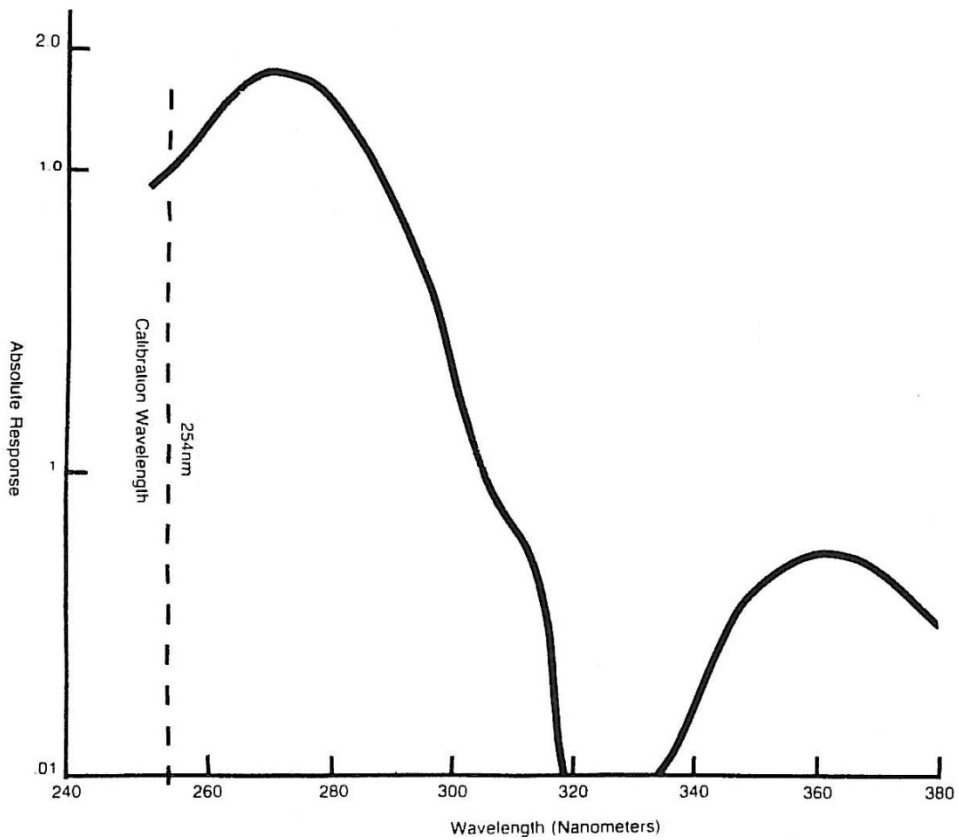

Figure 6: Typical UVX-25 Sensor Spectral Response

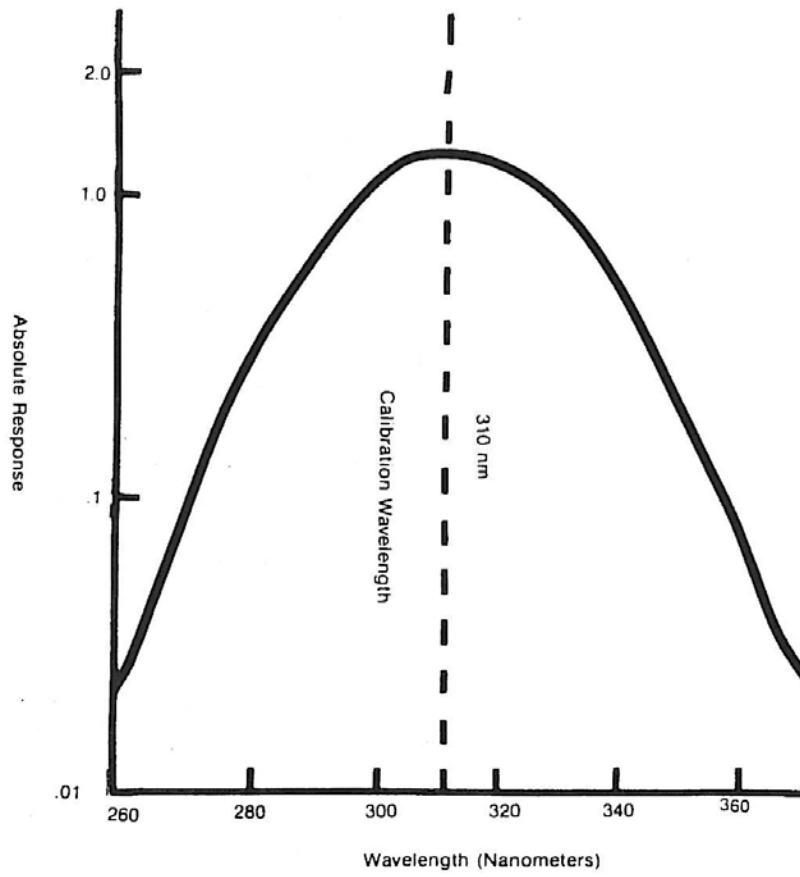

Figure 7: Typical UVX-31 Sensor Spectral Response

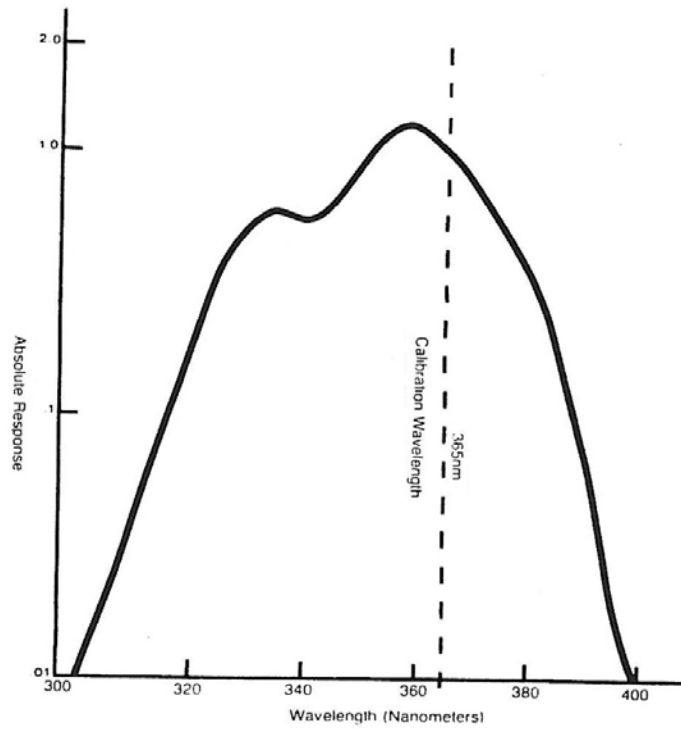

Figure 8: Typical UVX-36 Sensor Spectral Response

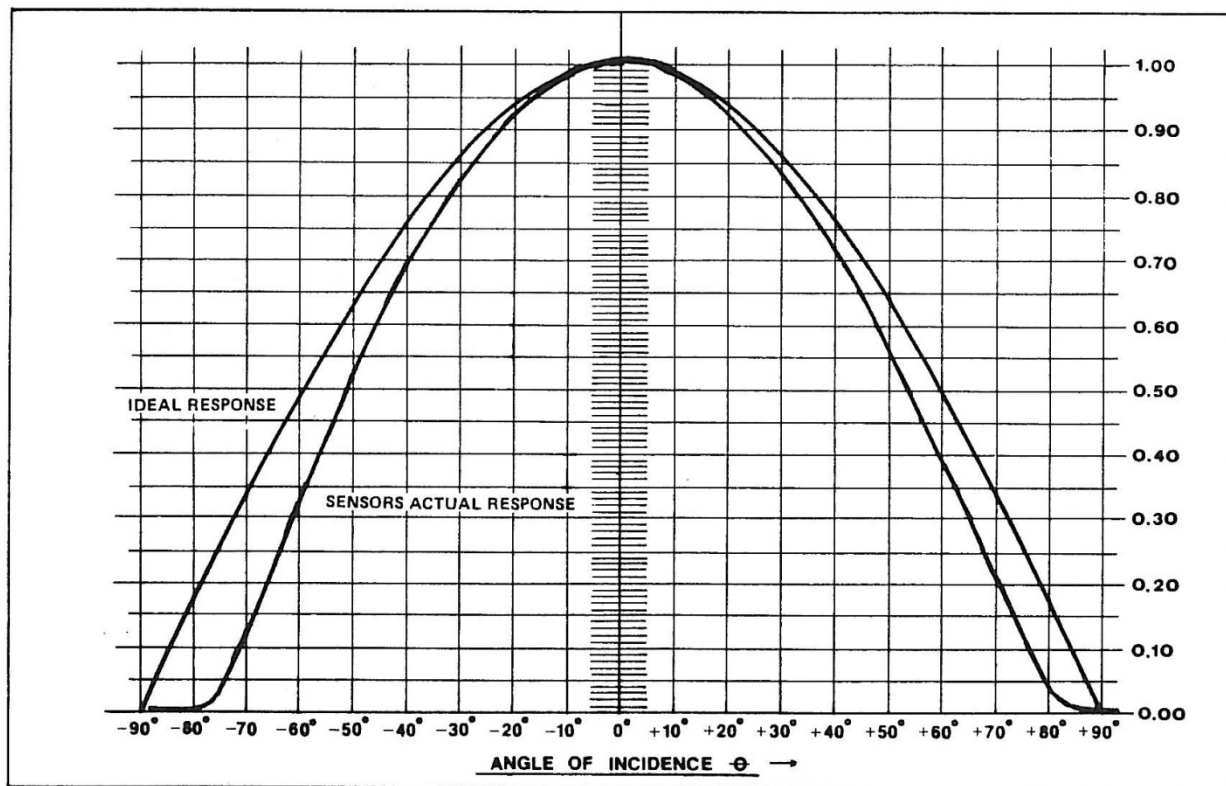

Figure 9: Typical Sensor Response Versus Incidence Angle

Calibration Traceability

For direct traceability to NIST standards, UVX sensors must be returned to the UVP calibrations laboratory for calibration once every 6 months. UVP does not stand behind calibrations performed by unauthorized companies.

UVX Series Sensors are calibrated by adjusting their response to match that of an UVP Transfer Standard Detector when exposed to radiant incidence of the appropriate calibration wavelength from a stable, effectively monochromatic source.

The calibration of UVP Transfer Standard Detectors is accomplished by measuring their response to a stable, effectively monochromatic radiant source of the appropriate wavelength. The absolute radiant incidence level from this source is set by simultaneously matching it with that of National Institute of Standards and Technology (NIST) standard of spectral irradiance. This calibration is performed at UVP calibrations laboratory a minimum of once every six months.

The NIST standard of spectral irradiance used by UVP is a 1000 watt tungsten lamp. This lamp is replaced after every 20 hours of operation.

Period of Calibration

UVP recommends recalibration of the UVX Series Sensors every 6 months, especially when used by the governmental agencies and in other areas of critical application.

NOTE: All sensors must be calibrated by the UVP calibrations laboratory for direct traceability to NIST standards.

In non-critical applications, the user may choose a longer period of time between calibrations. However,

the actual time that a sensor will remain within tolerance is dependent on such factors as care in handling and total dosage of radiation on the sensor filters (refer to “Solarization of Filters” in this manual).

Sensor Maintenance

The user should avoid performing corrective maintenance on the sensor. If required, the UVX Sensor should be returned to the factory.

Care of Sensor Case

CAUTION: Do not use abrasive cleaners on any part of the UVX Series Sensors or allow water to get inside the sensor.

The case of the UVX sensors is fabricated from a durable ABS plastic. As with all plastics, solvents should not be used in cleaning of the case. A high quality plastic cleaner or mild soap and water may be used to clean fingerprints, dust or dirt from the case. The contacts on the cable connector should not require attention.

Care of the Sensor Window

Dirt, dust or fingerprints on the sensor window will cause inaccurate readings. To ensure accurate readings, it is essential that the sensor window be kept clean. There are several ways of ensuring cleanliness. To remove dust or dirt, use a lens tissue or a cotton swab. To remove fingerprints, use a lens tissue or lint-free cloth moistened with alcohol. A high purity alcohol will ensure that no residue remains after the cleaning procedure.

General Precautions

Handling

The UVX Series Sensors, although rugged, should be protected from physical shocks, moisture and extremes of temperature.

Sensor Exposure

The sensors have been designed for minimum solarization effect as described elsewhere in this manual. However, it is suggested that the sensor be exposed to ultraviolet radiation only for the amount of time necessary to actually make a measurement. Excessive exposure may reduce the time between recalibrations.

Sensor Continuity Measurements

When an ohmmeter is used to check continuity of the sensor, be careful not to use a meter that applies more than 2 volts to the circuit. This is especially important when measuring continuity of the radiation sensor itself; i.e., between the ring and sleeve of the connector. (See schematic, Figure 10).

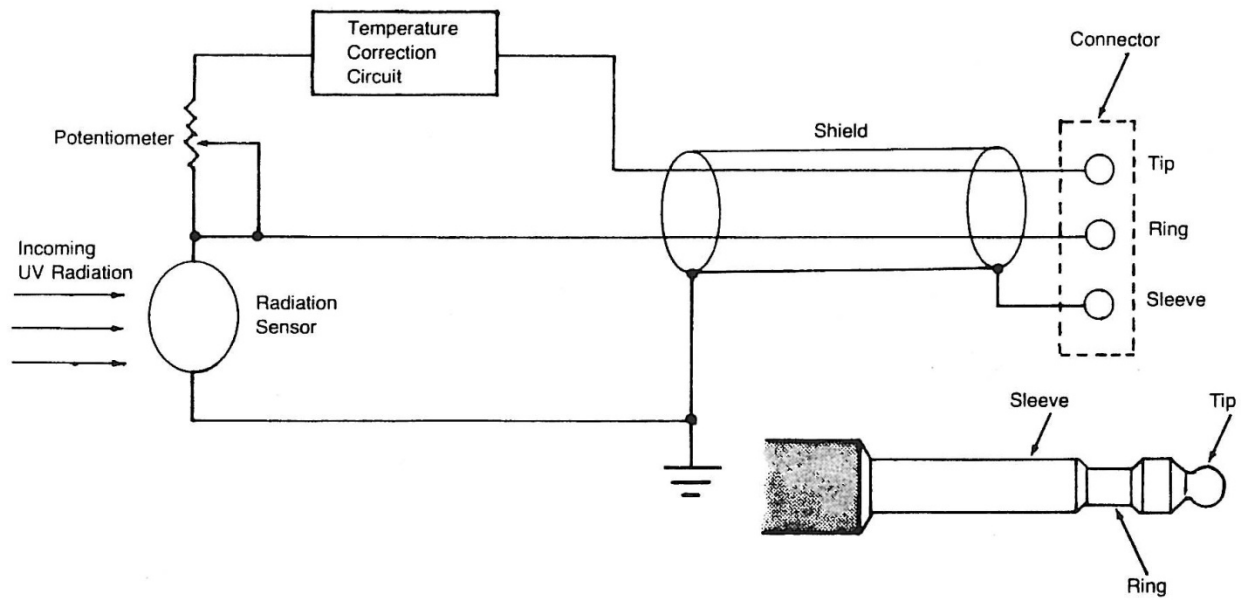
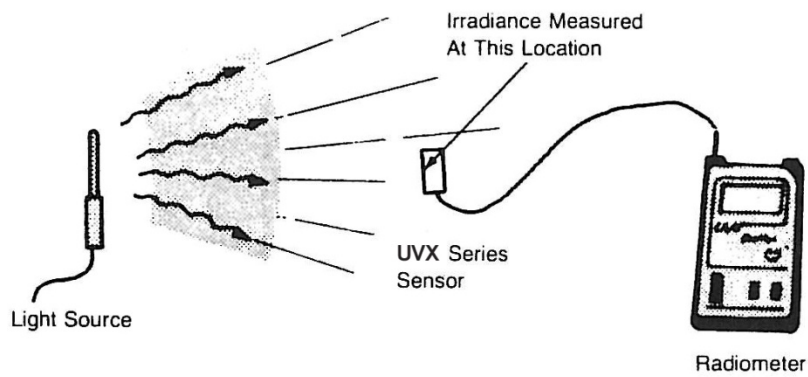
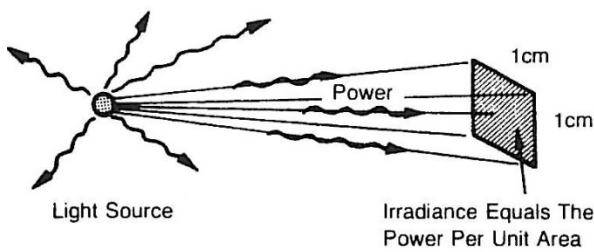

Figure 10: Schematic of UVX Series Sensor



(a) Measurement Setup



(b) Definition of Irradiance

Figure 1: Measurement of Irradiance

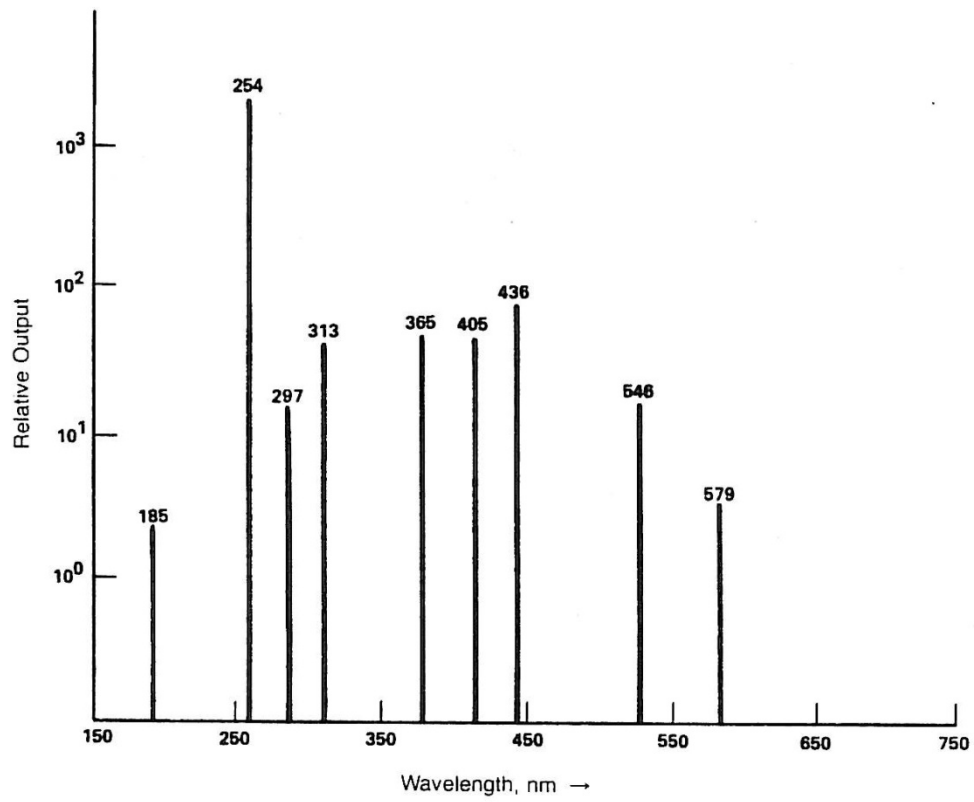

Figure 12: Typical Output From Low Pressure Mercury Lamp

Application Techniques

Definition of Radiant Incidence

The UVX Radiometer is an instrument for measuring radiant incidence, where radiant incidence is defined as the power per unit area incident on a surface at a location irradiated by a light source. See Figure 14. Using the metric system of units, radiant incidence is dimensionally given as power per unit area. The UVX Radiometer measures irradiance in milliwatts per square centimeter (mW/cm^2) and microwatts per square centimeter ($\mu\text{W}/\text{cm}^2$). A reading of $10.0 \text{ mW}/\text{cm}^2$ displayed on the UVX means that 0.010 watt of power is incident on an area of one square centimeter located at the surface on the sensor.

Depending on the sensor used, the irradiance readings will only have "meaning" at a particular wavelength or over a wavelength range and over a specified field of view.

Wavelength Considerations

Consider the wavelength of the light falling on the sensor. In the definition of irradiance, no restriction was placed on the wavelength of light generating the irradiance. In practice, however, most sensor systems are limited in sensitivity to a particular wavelength interval.

Several of the UVX sensors are designed to make irradiance measurements at particular wavelengths from sources of special interest to the user. Figure 6 provides an example of the wavelength sensitivity for a typical UVX-25 sensor. This sensor is calibrated at and designed to measure the 254nm wavelength output from low pressure mercury lamps. Figure 12 shows a typical output from such a lamp. These light sources are the most common type of shortwave emitters in use today. Although this source emits light at several different wavelengths, the major output occurs at 254nm. In fact, this wavelength accounts for approximately 90% of the total lamp output. Note that there are many spectral regions which yield no output. An output of the type shown in Figure 13 is commonly referred to as a "line source".

In many applications, the irradiance produced by this 254nm radiation is important and needs to be measured. The UVX Radiometer, using the UVX-25 sensor, is the answer to this measurement problem because of two important factors. One is that negligible radiation, other than the 254nm wavelength, occurs within the sensitivity wavelength region of the UVX-25 sensor. The second is that the sensor is calibrated to yield a correct measurement for 254nm light. Thus, the Radiometer system yields an accurate measurement of irradiance.

Consider now that the UVX-25 sensor is used to measure the output from the hypothetical light source given in Figure 13. Here, the only output within the sensitive wavelength range of the sensor occurs at 270nm wavelength. The sensor, however, is more sensitive to radiation at 270nm than at 254nm wavelength (see Figure 6). Therefore, the Radiometer system will yield a larger output. This output can be corrected to yield a more accurate answer by multiplying the displayed output by the factor 0.54. The correction factor was obtained by using Figure 6, and noting the ratio of the sensor sensitivity at 254nm to the sensitivity at 270nm.

The UVX-36 is calibrated to accurately read the irradiance from 365nm line source (B-100 type) lamps. When it is used to measure the irradiance from a phosphor coated long wave lamp it will read approximately 65% of the true value so that the meter reading should be multiplied by $1/.65 = 1.54$ to ascertain the true irradiance.

Figure 14 illustrates how UVX-25 sensors are calibrated. Each of the curves in the family of curves plotted represents slight differences in spectral sensitivity for different sensors. These small differences result from variations in filter transmission and detector response. The important point to note, however, is that all the curves are forced, as a result of calibration, to yield the same response at 254nm wavelength. Sensors calibrated in this manner are said to be calibrated to a line source; in this case to a line source at 254nm wavelength.

UVP manufactures other sensors which are also calibrated using line sources at other wavelengths. The user must take special precautions when using "line source calibrated sensors" to measure irradiance from lamps radiating at wavelengths other than those for which the sensor was calibrated. A common application of this type occurs when measuring irradiance from phosphor coated lamps which emit continuously over a broad wavelength region. Figure 15 shows an emitter.

When measuring a phosphor coated lamp a true absolute reading will only be obtained if the measurement taken is multiplied by a correction factor. This correction factor can be determined by using the following equation.

$$CF = \frac{\int_{\lambda} A}{\int_{\lambda} [A \times B]}$$

where:

CF = correction factor,

A = lamp spectral output,

B = radiometer response normalized
at the calibration wavelength

λ = the wavelength at which
the measurements are taken

Field of View and Distance

Figure 16 shows two different sensors measuring the output from a lamp of extended length. The sensor S^1 has a larger field of view or acceptance angle than the sensor S^2 . Since it is radiant incidence that is being measured, sensor S^1 will yield a larger output than S^2 because the emission from the total lamp length is being sensed.

Remember it is power incident upon the sensor surface that is being measured. Obviously, some of the power comes from the ends of the lamp as well as the middle and the entire lamp length. Therefore, it is best to use sensors having a large field of view when measuring radiant incidence from extended sources.

If this is not possible, then the sensor must be backed away until the entire source is within the field of view of the sensor. Of course, this will reduce the overall radiant incidence on the sensor and correspondingly the sensor output.

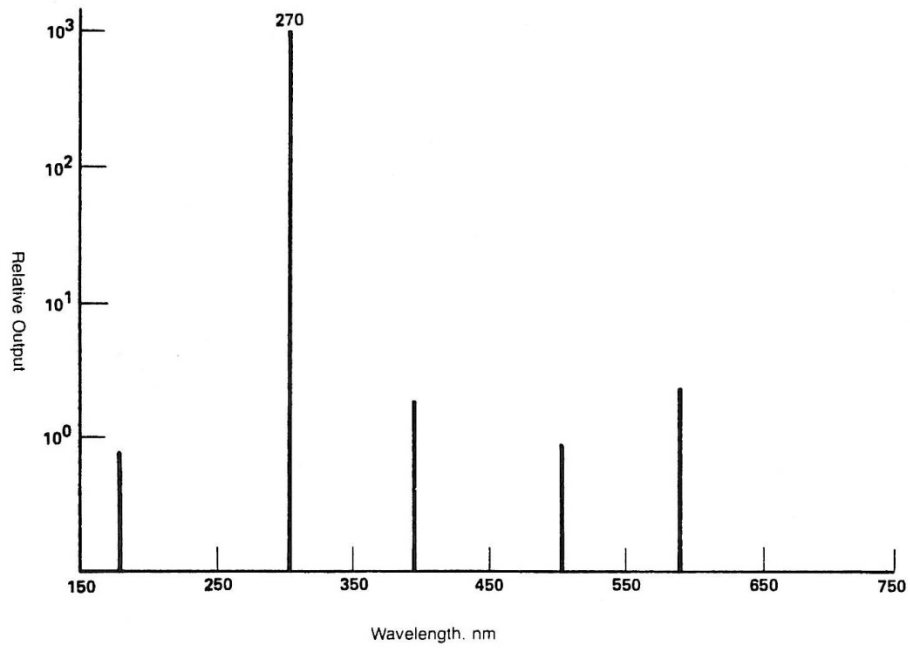

Figure 13: Hypothetical Light Source Having an Output at 270nm Wavelength

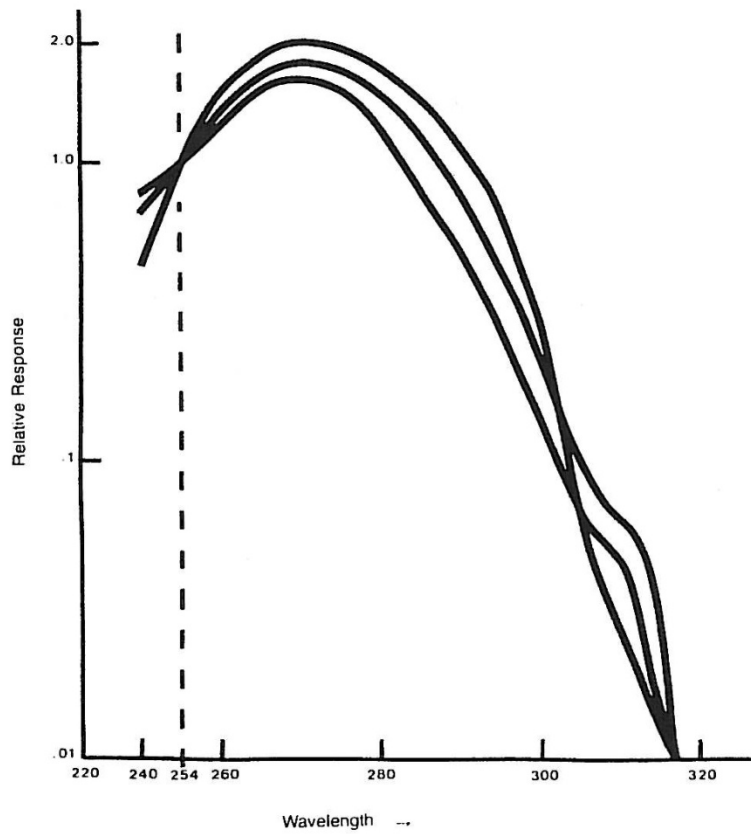

Figure 14: Response of Three Sensors Calibrated to Yield the Same Output at 254nm Wavelength

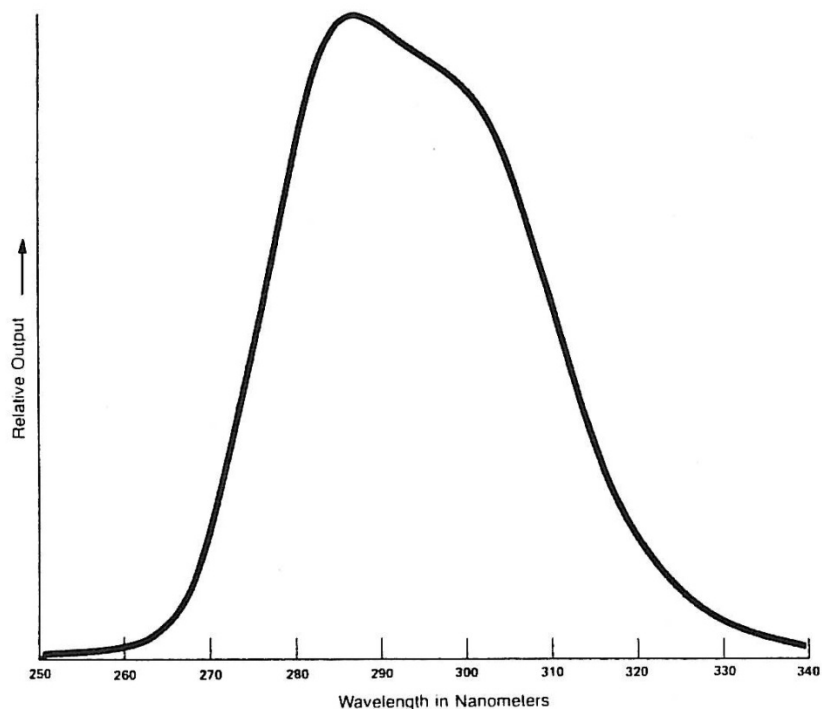

Figure 15: Continuous Emitter, 285nm Phosphor Coated UV Lamp

Cosine Response

For a sensor to accurately measure irradiance, it is necessary that it preserve a cosine relationship which depends on the angle of incident radiation. This relationship is a function of the projected area of the sensor, as seen in a plane normal to the incident light. See Figure 17.

Since the projected area is proportional to the power that the sensor intercepts, the irradiance measured for radiation incident at an angle θ will be given by $I_0 \cos \theta$. I_0 is the irradiance that would be measured if the sensor were pointed directly toward the incident region. Sensors that "weigh" their response in this manner are said to be cosine corrected.

The Polar Plot in Figure 18 has been drawn from the curve of Figure 10 to show how the UVX sensor compares to the perfect cosine response. The sensor is identified by the broken curve in the figure. The solid curve, also shown, identifies a perfect cosine response. The UVX Series Sensors offer this same high degree of cosine corrected response.

Summary

Many parameters affect radiant incidence measurements. These parameters can, however, be divided into two classes; those which are a function of the sensor and those which are not. The most important specifications of a sensor design have been discussed above. They are: spectral response, field of view, distance and cosine response.

Safety Precautions

It is essential that adequate precautions be taken in applications using ultra-violet light sources. Prolonged exposures to high intensities can cause painful inflammation of the conjunctiva (the outer membrane of the eye) as well as histological effects in the cornea, iris, and lens of the eye. Reddening or even burning of the skin (erythema), similar to sunburn, will be caused by excessive exposure to ultra-violet energy. In extreme cases, permanent harmful effects can occur.

Individuals vary greatly in their sensitivity to ultra-violet radiation. Children, for example, are much more sensitive to ultra-violet than are adults. Prolonged exposure of the unprotected skin and eyes should always be avoided, and people with fair skins should avoid even occasional exposures. The effects of ultra-violet exposure may not be felt immediately. Normally, several hours will elapse before over exposure is detected.

Recommended reading: "Criteria for a Recommended Standard -Occupational Exposure to Ultra-Violet Radiation", published by U.S. Department of Health, Education and Welfare, Public Health Service Document HSM-73-11009, and "Practice for Occupational and Educational Eye and Face Protection", published by the United States of America Standards Institute, Document USAS Z 87.1-1968.

These publications provide guidelines for maximum exposure to ultra-violet radiation in terms of time intensity, and wavelength. The type of protection required to prevent over exposure to the eyes and skin will vary depending on each of these parameters and each individual's susceptibility.

The wearing of protective eyewear, which greatly attenuates the transmission of ultra-violet radiation, is always recommended when working in such environments. For low exposures, this preventive method may be the only protection necessary.

The UVX Radiometer system is capable of measuring radiant incidence levels which are extremely hazardous to unprotected personnel. In these cases (see recommended reading above), full face shields and protective clothing over all exposed areas of the body are required.

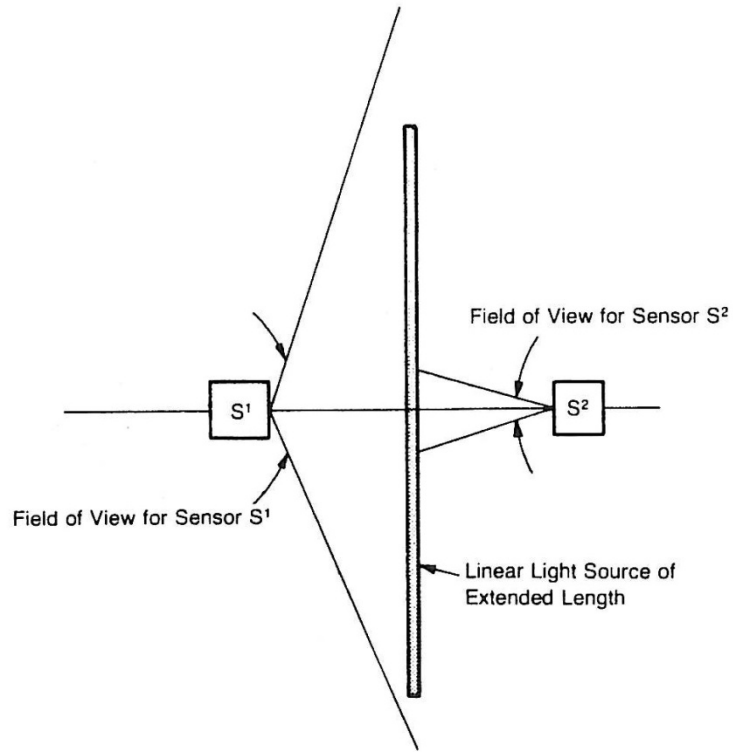

Figure 16: Example, Illustrating Why Sensor Field of View is Important When Measuring Irradiance

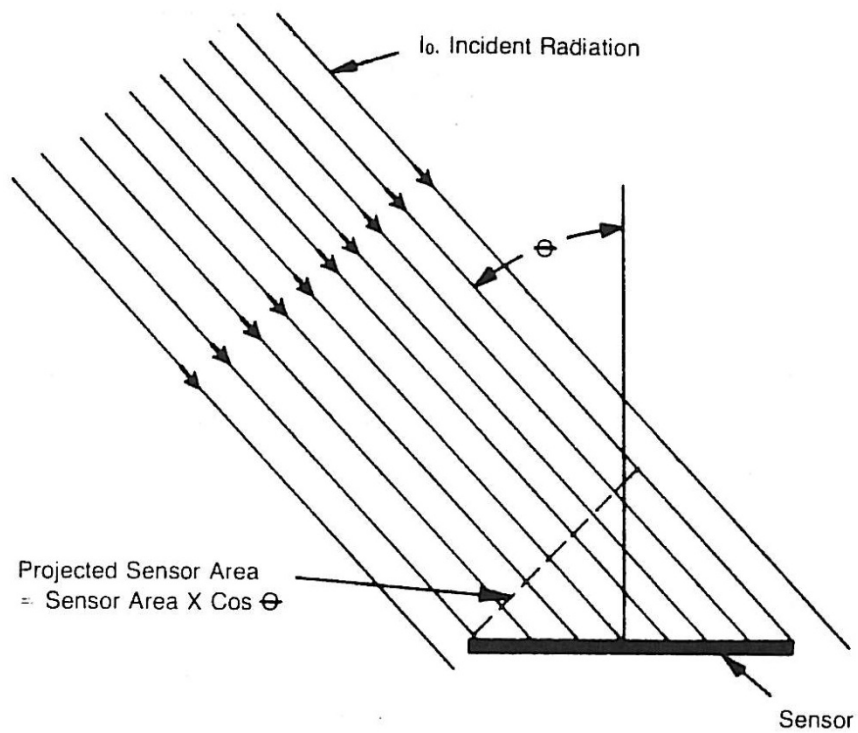

Figure 17: Projected Area of Sensor

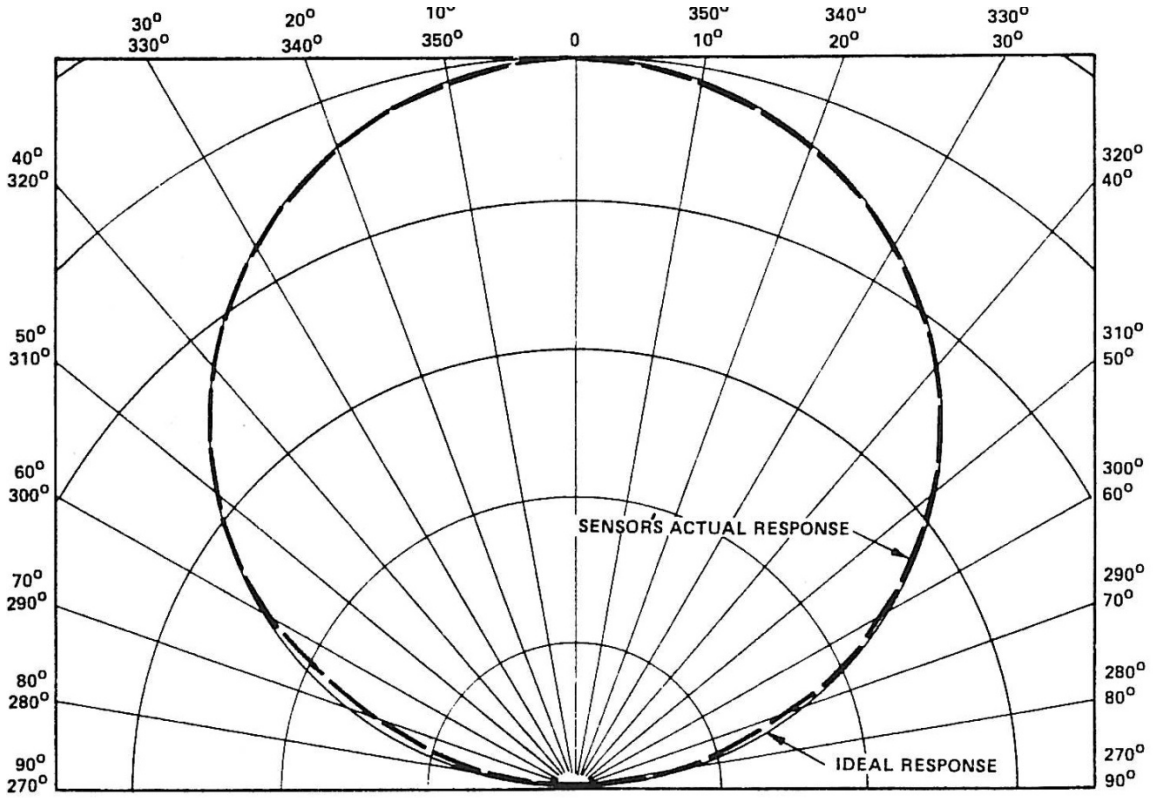

Figure 18: Cosine Response of Typical UVX Sensor (Polar Plot)

Component List, Replacement Parts, and Options

Component List

The following list is the components used on the printed circuit board assembly P/N 57-0005-04.

PART NO.	DESCRIPTION	COMPONENT DESIGNATION
57-0005-01	Printed Circuit Board, UVX Radiometer	
57-0041-10	Resistor, 4.99K, 1/8W, 1%	R1
50-0041-21	Resistor, 536 ohms, 1/8W, 1%	R2
50-0041-22	Resistor, 191 K, 1/8W, 1%	R3
50-0041-12	Resistor, 16.2K, 1/8W, 1%	R4
50-0025-05	Resistor, 1M, 1/4W, 5%	R5, R10, R11
50-0041-13	Resistor, 475K, 1/8W, 1%	R6
50-0041-14	Resistor, 10K, 1/8W, 1%	R7
50-0041-15	Resistor, 113K, 1/8W, 1%	R8
50-0041-16	Resistor, 51.1 K, 1/8W, 1%	R9
50-0025-07	Resistor, 270K, 1/4W, 5%	R14
50-0025-04	Resistor, 10K, 1/4W, 5%	R13
50-0041-19	Resistor, 1.2M, 1/4W, 5%	R12
50-0041-20	Resistor, 2.4M, 1/4W, 5%	R15
52-0011-01	Capacitor, .002uf 1000V, 20%	C2
52-0004-06	Capacitor, .1 uf, 12V, 20%	C3, C5, C8, C11, C12
52-0002-01	Capacitor, .22uf, 100V, 10% Mylar	C4
52-0002-02	Capacitor, .22uf, 100V, 10% polypropylene	C6
52-0012-01	Capacitor, .047uf, 250V 10%	C7
52-0004-07	Capacitor, .1 uf, 100V 10%	C9
52-0013-01	Capacitor, 100pf, 500V, 5%	C10
52-0002-03	Capacitor, .22uf, 50V, ± 80% to -20%	C13
52-0001-02	Capacitor, 10uf, 16V, -10% to +50%	C15, C16
51-0007-02	Diode, 1N914	CR1, CR2
51-0002-02	Rectifier, 1 Amp, 1N4001	CR3
51-0023-02	Transistor, 2N3904	Q1
50-0012-08	Potentiometer, Trimpot, 20K, 15 Turns	RV1
50-0012-09	Potentiometer, Trimpot, 100K, 15 Turns	RV2
50-0012-05	Potentiometer, Trimpot, 10K, 15 Turns	RV3
53-0014-05	Switch, Rocker, PCB, 5A. 125V	S1
53-0052-02	Switch, Rocker, PCB 28 VDC DPDT	S2
53-0052-01	Switch, Rocker, PCB 28 VDC SPOT	S3
51-0029-01	Integrated Circuit, OP97	U1
51-0028-01	Integrated Circuit, 4030	U2
51-0030-01	Converter, A/D, 3-1/2 Digit Single Chip LCD	U4
55-0064-01	Terminal, Circuit Socket, 20 Pin	
51-0031-01	Display, Liquid Crystal, 3-1/2 Digit, .5" High	D1
55-0063-02	Connector, Female, Printed Circuit Board	J1
55-0066-01	Battery Snap, I Type, 6" Leads	

In addition to the components listed above, the UVX that includes the Recorder Output Option (57-0005-05) also has the following components.

PART NO.	DESCRIPTION	COMPONENT DESIGNATION
52-0004-06	Capacitor, .1 μ , f, 12V, 20%	(C14)
55-0063-01	Phone Jack, Enclosed, Subminiature	(J2)
51-0029-01	Integrated Circuit, OP97	(U3)
57-0005-02	PC Board Assembly	

Replacement Parts

Replacement parts may be ordered from UVP or your electronics component supplier. It is important when ordering parts to include in your order the part number, instrument type, and serial number.

Following is a list of replacement parts required for the UVX Radiometer.

PART NO.	DESCRIPTION	COMPONENT DESIGNATION
51-0023-02	Transistor, 2N3904	(Q1)
51-0029-01	Integrated Circuit, OP97	(U1, U3)
51-0028-01	Integrated Circuit, 4030	(U2)
51-0030-01	A/D Converter, 3-1/2 Digit Single Chip	(U4)
51-0031-01	Liquid Crystal Display	(D1)

Note: There are no replacement parts for the UVX sensors. In case of damage or malfunction, the sensor must be returned to UVP for repair and recalibration.

Options

A number of options are available for use with the UVX Radiometer. These options expand the functions of the UVX as well as provide greater user application and adaptability to specific requirements.

Any of these options may be ordered separately or at the time of purchase. They are:

UVX-25 Short Wave Sensor (254nm)	P/N 97-0016-01
UVX-31 Mid-Range Sensor (310nm)	P/N 97-0016-04
UVX-36 Long Wave Sensor (365nm)	P/N 97-0016-02
10:1 Attenuator Adapter	P/N 98-0035-01

Warranty

UVP's quality instruments are guaranteed to be free of defects in materials, workmanship, and manufacture for one (1) year from date of purchase. Consumable and disposable products, including, but not limited to lamps or light tubes, filters, or rechargeable batteries, are guaranteed to be free from defects in manufacture and materials for ninety (90) days from date of purchase. If equipment failure or malfunction occurs during the warranty period, UVP shall examine the inoperative equipment and have the option of repairing or replacing any part(s) which, in the judgment of UVP, were originally defective or became so under conditions of normal usage and service.

No warranty shall apply to any instrument, or part thereof, that has been subject to accident, negligence, alteration, abuse or misuse by the end-user. Moreover, UVP makes no warranties whatsoever with respect to parts not supplied by UVP or that have been installed, used and/or serviced other than in strict compliance with the instructions appearing in the operational manual supplied to the end user.

In no event shall UVP be responsible to the end-user for any incidental or consequential damages, whether foreseeable or not, including, but not limited to property damage, inability to use equipment, lost business, lost profits, or inconvenience arising out of or connected with the use of instruments produced by UVP. Nor is UVP liable or responsible for any personal injuries occurring as a result of the use, installation and/or servicing of equipment.

Warranty is void if calibration is performed by any company other than UVP prior to the end of warranty period.